

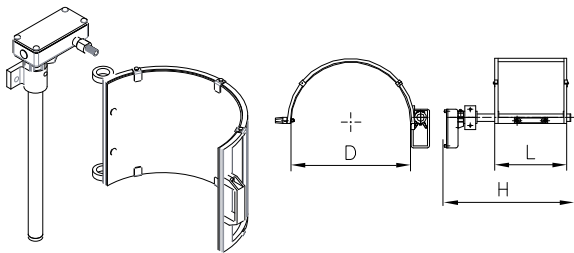

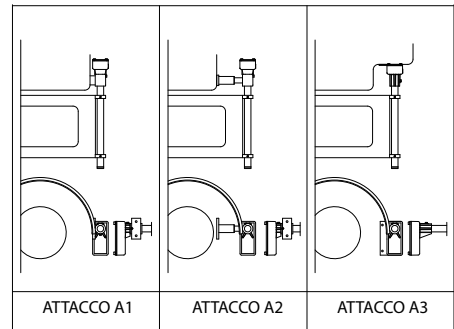

TMT



Cod.art.	300	350	400	450	500	600
D	300	350	400	450	500	600
L				240		
H				415		

 Protezione per tornio composta da una cupola in acciaio e materiale plastico antiurto e palo di supporto con microinterruttore di sicurezza.

 Protective guard for lathe consisting of a steel and impact resistant plastic hood and support pole with safety micro-switches.

 Protection pour tours composée par une coupole en acier et matériel plastique antichoc et poteau de support avec microinterruteur de sécurité.

 Protección para torno formada por una cúpula de acero y material plástico antichoque y palo de sostén con microinterruptor de seguridad.

TGT

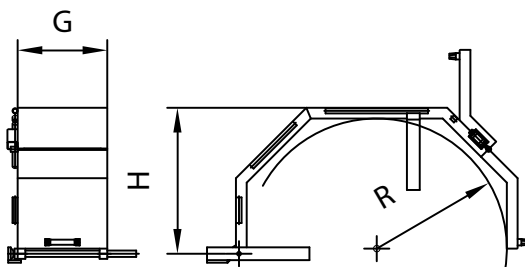

Cod.art.	R	G	H
TGT 700/800	400	300	460
TGT 1000/1200	600	350	660

 Protezione per torni con grandi autocentranti. Realizzata in lamiera di acciaio con doppio ribaltamento e due microinterruttori di sicurezza.

 Protection for lathe with self-centring lugs. Created in steel sheet with double tilting and two safety micro-switches.

 Protection pour tours à grands auto centreurs. Réalisée en tôle d'acier a double basculement et deux micro-interrupteurs de sécurité.

 Protección para tornos con dispositivos de centrado automático de grandes dimensiones. Realizada de chapa de acero con doble basculamiento y dos microinterruptores de seguridad.